

Assembly & Installation Instructions: Conform Knoll® Antenna® Adaptor CONF-ADPT-KA-S

Parts Included, Knoll® Antenna® Adaptor

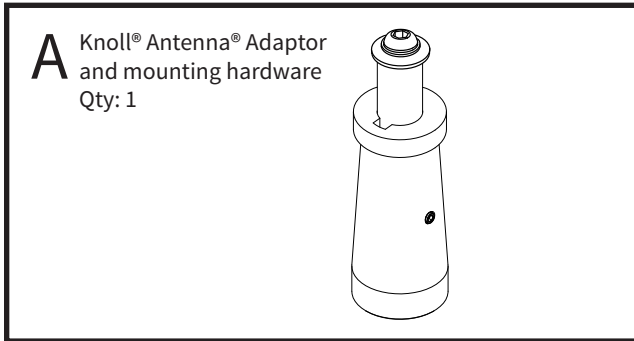

Parts Included, Hardware kit

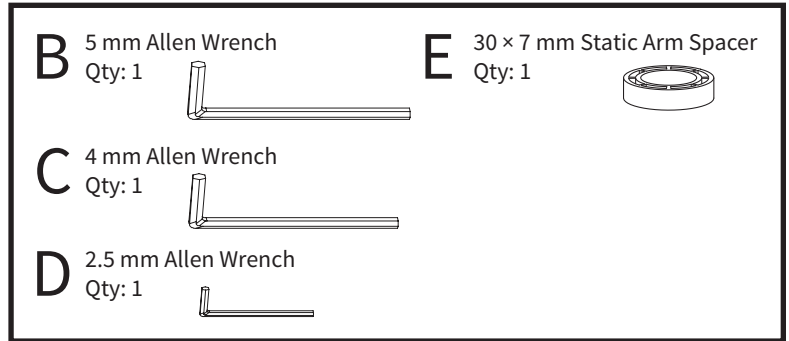

Required Parts Sold Separately

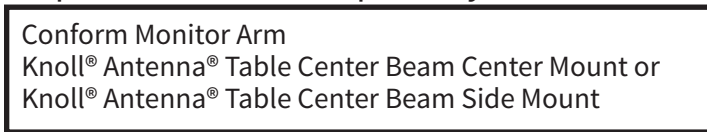

Tools Required

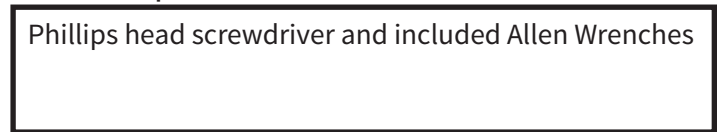

1 Remove Bolt & Washers from Adaptor

Remove the M8 × 90 mm Bolt and Washers from Knoll® Antenna® Adaptor (A).

Leave the Articulating Arm spacer in place.

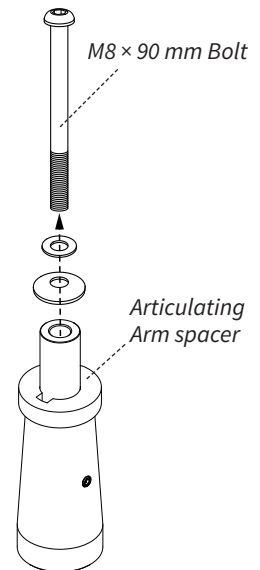

2 Remove Knoll® Antenna® Center or Side Mount From Center Beam

If installed, remove the Knoll® Antenna® Center Beam Side Mount or Center Mount according to manufacturer instructions. You will need to access the bottom of the unit to attach the adaptor.

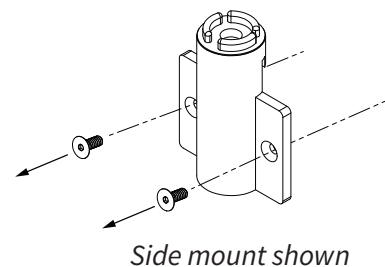

3 Attach Knoll® Antenna® Adaptor to Center Beam Mount and Reattach to Antenna® System

- a** Place the Knoll® Antenna® Adaptor (A) onto the Knoll® Center Beam Center Mount or Side Mount. Use the bottom screw from the Knoll® Antenna® System to affix the Center Beam Mount to the Knoll® Antenna® Adaptor.
- b** Use the screws supplied with Knoll® Antenna® System to re-attach the Center Beam Mount unit with the Knoll® Antenna® Adaptor to the Center Beam of the Knoll® Antenna® System.

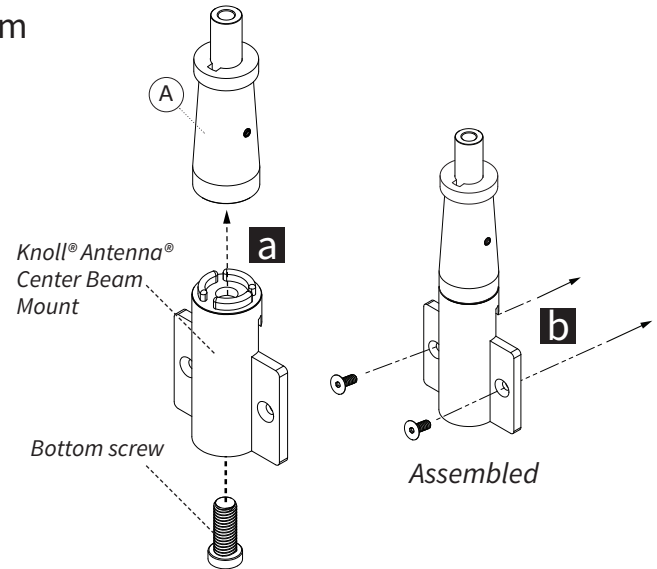

4 Replace Spacer for Static Arm Mounting

If you are mounting a Static Arm, replace the pre-installed Articulating Arm Spacer with the Static Arm Spacer (E).

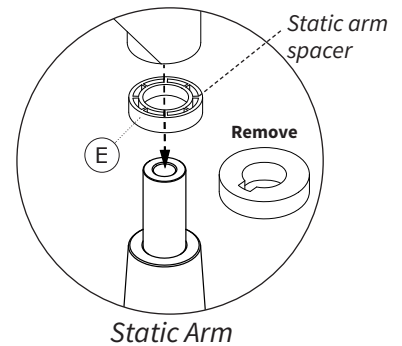

5 Ready for Arm Installation

You are now ready to attach your selected Conform Monitor Arm (sold separately).