

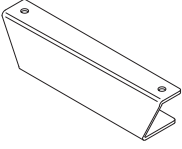

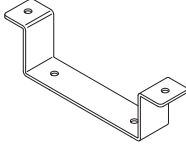





# Assembly Instructions: Bench Mount Kit, BKM-1-B

## Parts Included

<b>A</b> Face Plate Bracket Qty: 1 	<b>B</b> Track Bridge Brackets Qty: 2 	<b>C</b> #10-32 x 3/8" Pan Head Screws Qty: 6 	<b>D</b> #10-32 x 5/8" Pan Head Screws Qty: 6 	<b>E</b> #10-32 x 3/4" Pan Head Screws Qty: 6 
		<b>F</b> Spacers, 1/4" Qty: 6 	<b>G</b> Spacers, 3/8" Qty: 6 	<b>H</b> #10-32 Keps Nuts Qty: 6 
		<b>I</b> #12 x 3/4" Wood Screws Qty: 6 		

## Required, sold separately

Worksurface  
Keyboard Arm

✓ Verify that you have all the hardware needed for the assembly.

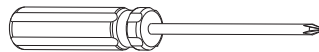

Phillips-head screwdriver



3/8" driver or wrench

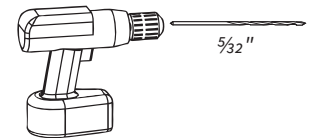

Drill/Driver with 5/32" drill bit

## 1 Attach Brackets to Keyboard Arm Track

The Bench Mount Kit can be configured in three different heights. See chart at right for hardware recommendations.

Spacing Chart

Height	Spacer	Screw
1 1/8"	None	C
1 3/8"	F	D
1 1/2"	G	E

- a** Attach the Face Plate Bracket using two Pan Head Screws (C, D or E). Insert through the front most holes in track from below. Use Spacers (none, F or G) as required between track and bracket. Install two Keps Nuts (H) and tighten securely.
- b** Attach Track Bridge Bracket to the Center Zone of Keyboard Arm Track, using two Pan Head Screws (C, D or E). Insert through the holes in the track best suited to avoid obstructions as far forward as possible. Use Spacers (none, F or G) as required between track and bracket. Install two Keps Nuts (H) and tighten securely.
- c** Attach Track Bridge Bracket to the Back Zone of Keyboard Arm Track, using two Pan Head Screws (C, D or E). Insert through the holes in the track best suited to avoid obstructions as far rearward as possible. Use Spacers (none, F or G) as required between track and bracket. Install two Keps Nuts (H) and tighten securely.

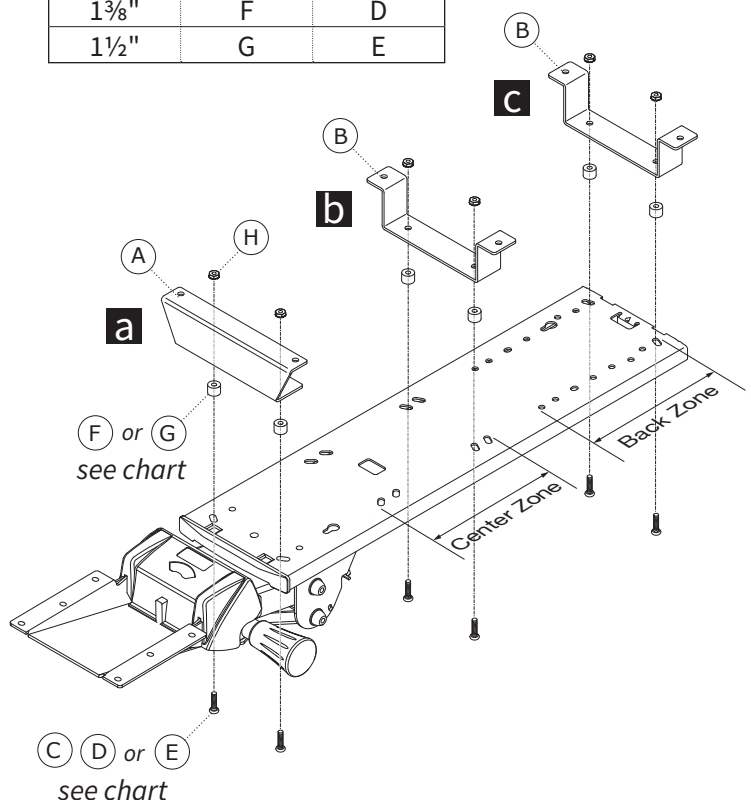

## 2 Attach Track Assembly to Worksurface

Locate appropriate area under worksurface for track. Face Plate must be placed a minimum of  $\frac{1}{2}$ " in from front edge of worksurface. Mark holes on surface. Using  $\frac{5}{32}$ " drill bit, drill pilot holes  $\frac{3}{4}$ " deep.

**Do not drill through worksurface!**

Use #3 Phillips-head screwdriver to attach arm and track using six #12  $\times \frac{3}{4}$ " Wood Screws (F).

